

# Water is everywhere.

How many ways does your church use water?

Circle all the ways below!

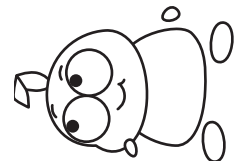
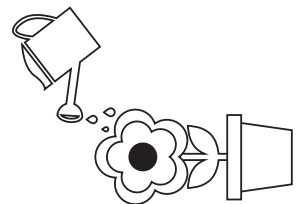
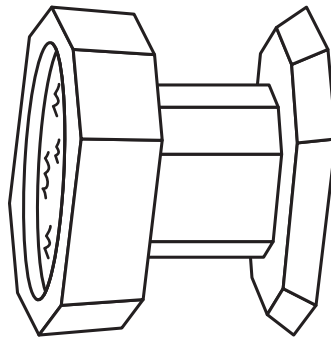
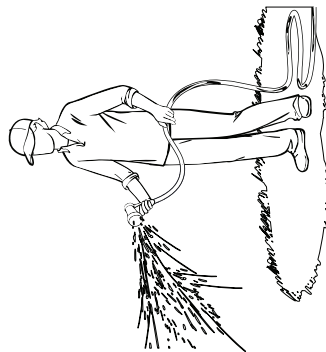
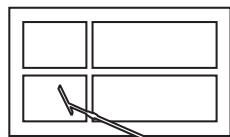
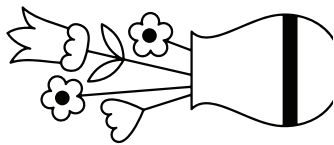

If Pastor Pete is washing windows, is he baptizing them, too?

Fold here

Whirl Year A Spring Director Guide. [wearesparkhouse.org](http://wearesparkhouse.org). © 2019 Sparkhouse. All rights reserved. May be reproduced for local use only provided each copy carries this notice.

Fold here

# Lent 3

YEAR A • MARCH 15, 2020



Pre-Reader



Today is the third Sunday of LENT.

The color of Lent is PURPLE. Color the objects that can be purple.

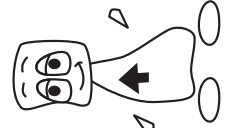
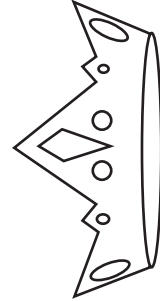
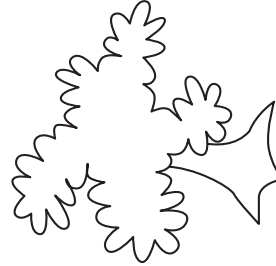
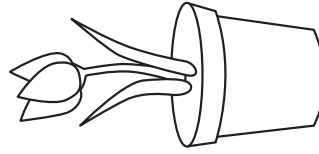
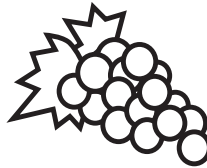
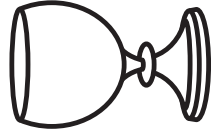

Purple is the color of ROYALTY.

# The woman at the WELL.

Draw a line to match the boxes to where they go in the picture.

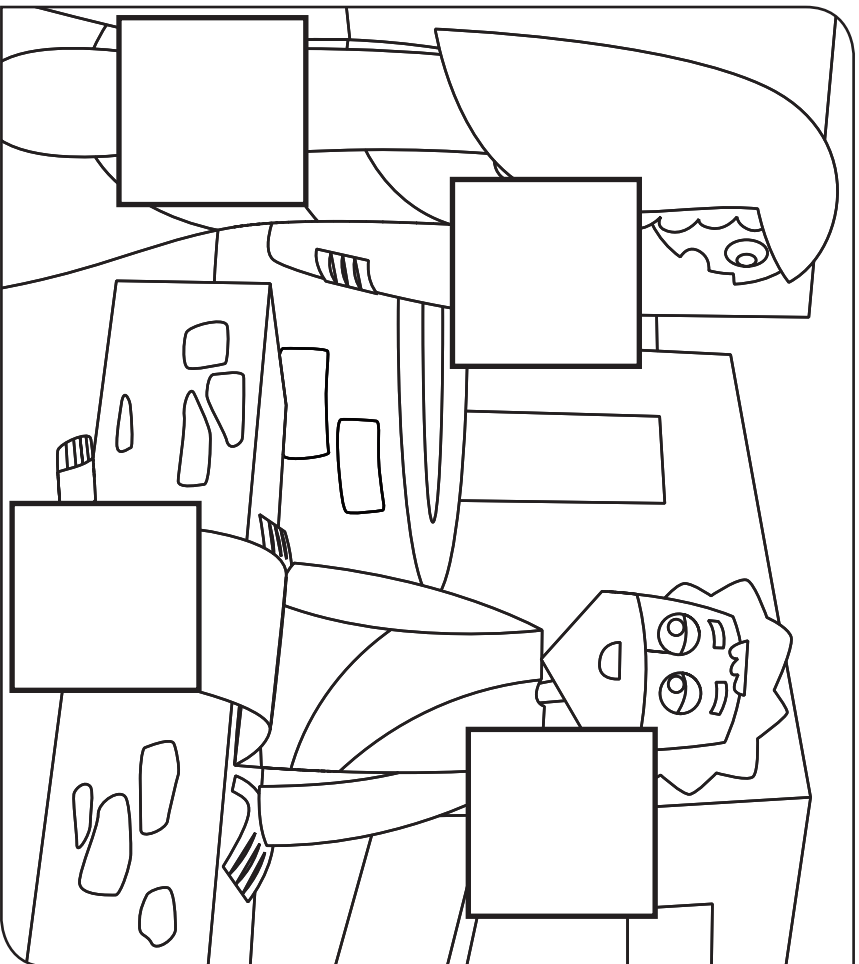
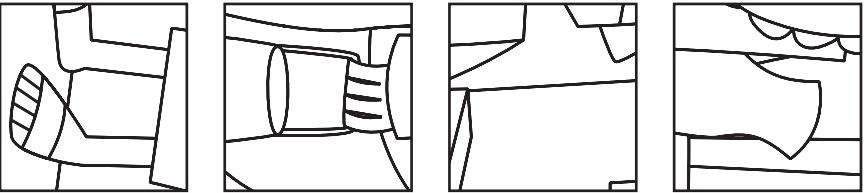

I hope she was careful.  
Wells are deep!

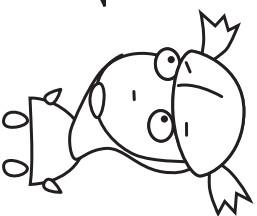

Today our church family prays for ...

## Water is everywhere.

Churches use water in many ways. What ways does your church use water? Draw pictures and write words to DESCRIBE all of the ways your church uses water.

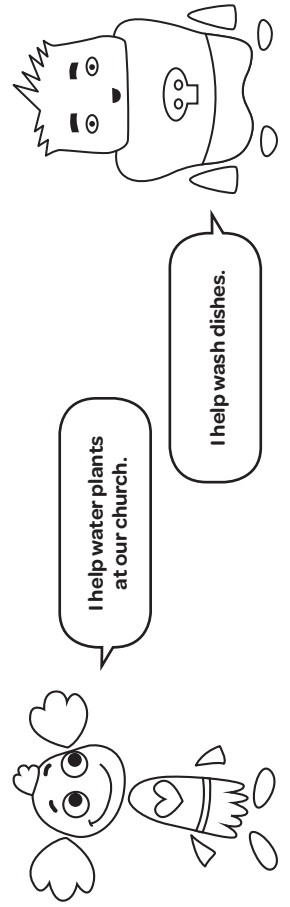

Fold here

Whirl Year A Spring Director Guide. [wearesparkhouse.org](http://wearesparkhouse.org). © 2019 Sparkhouse. All rights reserved. May be reproduced for local use only provided each copy carries this notice.

Fold here

# Lent 3

## YEAR A • MARCH 15, 2020



Reader



### Today is the third Sunday of LENT.

What do you see that's purple in your church? Write it down or draw it on Leo's blackboard!

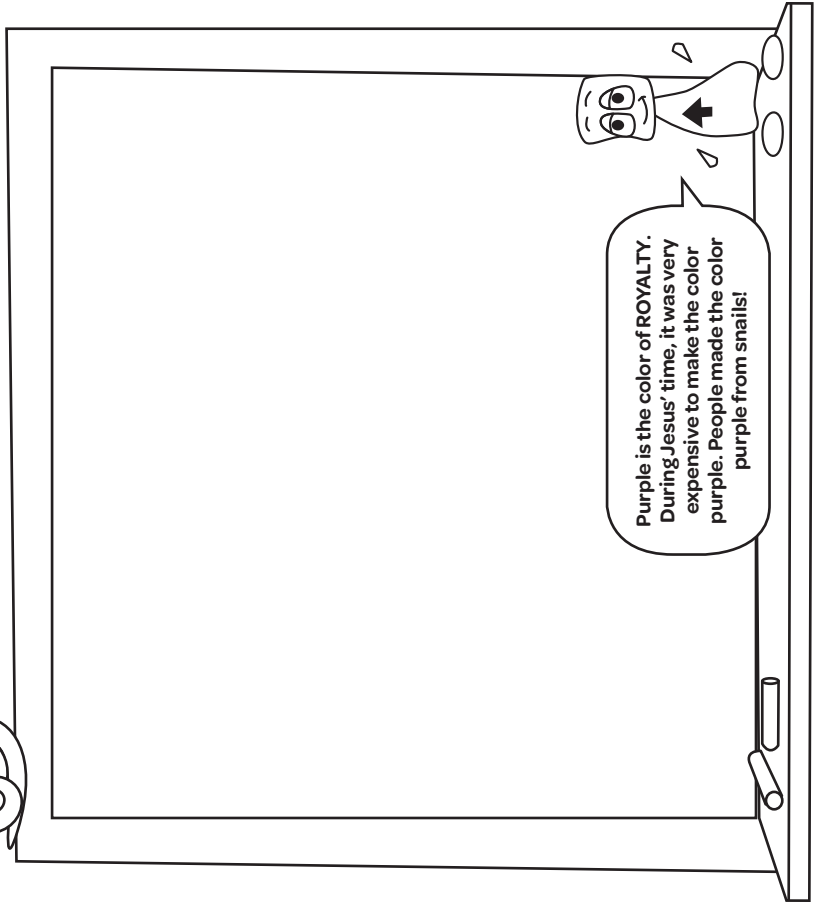

# The woman at the WELL.

Can you draw the picture to match the picture on the left? Try it!

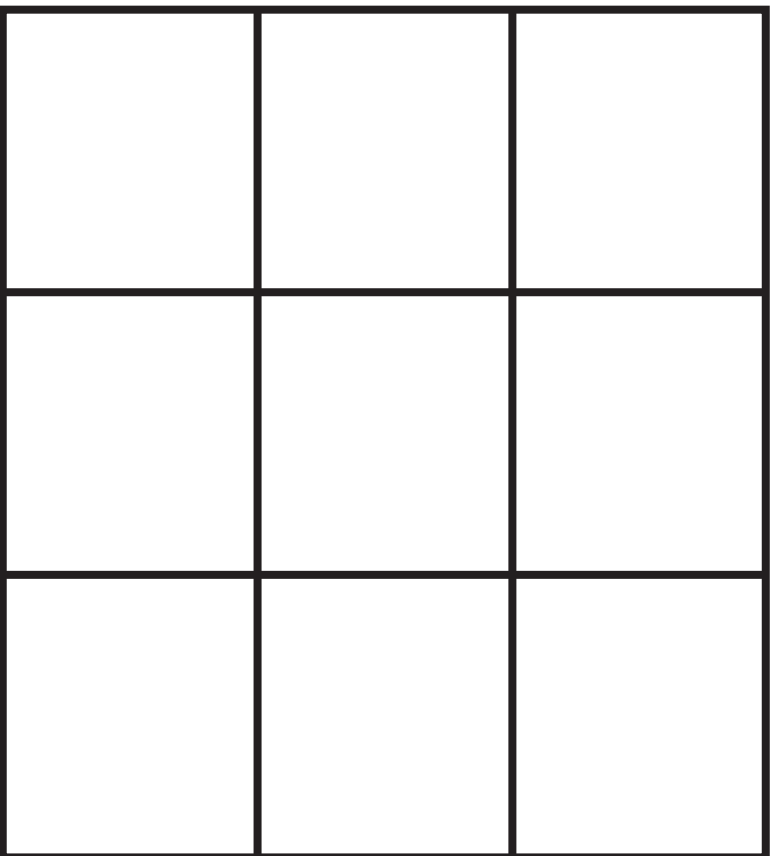
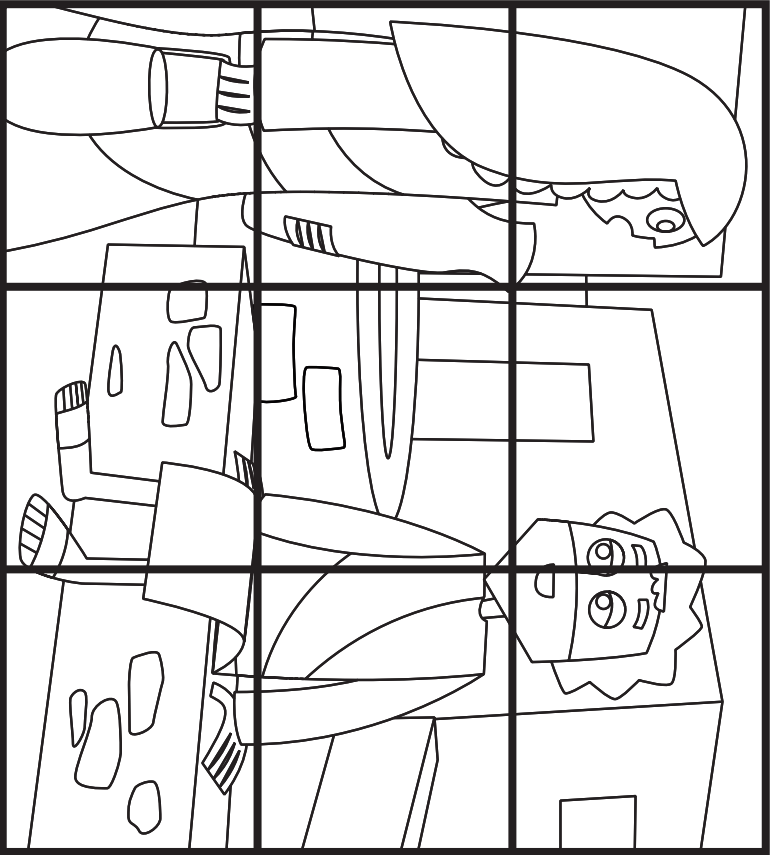

Jesus talked to everyone!

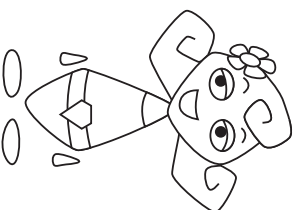

Today our church family prays for ...